

RoHS 包装图

前空10穴 160mm Min 6000mm 包装数量300PCS 后空10穴 200mm Min

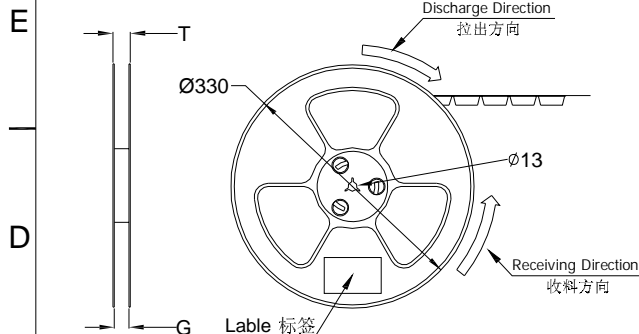

COVER TAPE PEEL STRENGTH:20~120g
剥离力量20~120g
速度 PEEL SPEED:300mm/minute

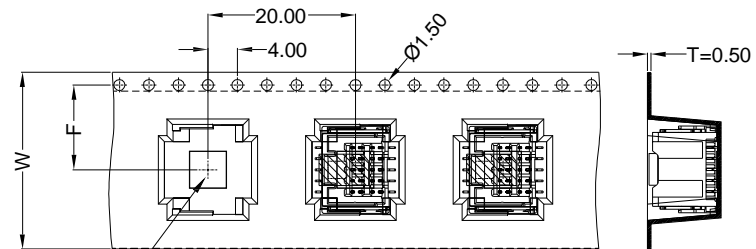
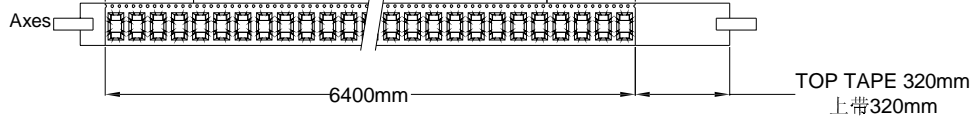
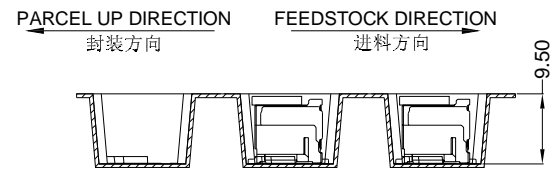
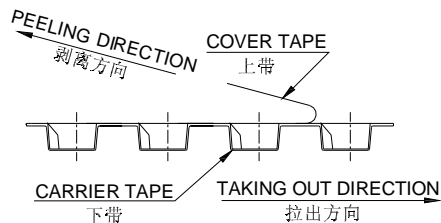

Lable 标签
Single hole: None Hole Side
单孔: 贴无链孔侧
Double hole: Elliptical Hole Side
双孔: 贴椭圆孔侧

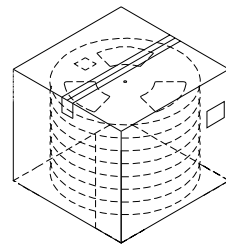
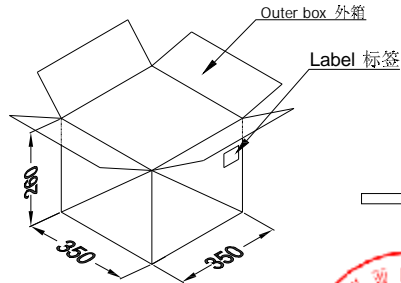
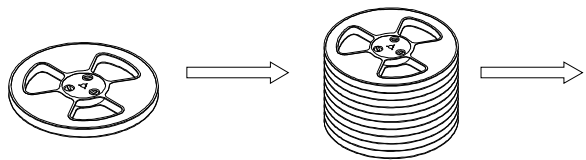

A1508WVS-2*05-LPSW	
Pin No.	A1508WVS-2*05HF
W	24
S	-
F	11.5
T	28.40
G	24.40
Cover Tape(W) 上带(宽度)	21.3
Carrier Tape(Color) 下带(颜色)	透明色
REEL / PCS	300
CARTON / R	8R
CARTON / PCS	2400

Note:

- Carrier Camber Is Within 1mm In 100mm ; 带长100mm 内容许弯曲度1mm
- 10 Sprocket Hole Pitch Cumulative Tolerance±0.2MM ; 圆孔十个孔距离累计允许公差为±0.2mm
- Carrier tape Material for PS; 下带材质为PS材质; Color颜色: Natural透明色
- Bracer保护带: Color颜色: Natural透明色; 厚度0.40mm最小; 无卤
- Thickness=0.50±0.05 ; 材料厚度为0.50±0.05mm
- Carton material纸箱材质:K=K; Carton Thickness 纸箱厚度: 6~7mm



DATE	REV	ECN NO.	DESCRIPTION	MODIFY	APPROVAL
1					
2					
3					
4					

GENERAL TOLERANCE	
.X	±0.30
.XX	±0.20
.XXX	±0.10
X°	±0.2°

	东莞市国亚电子有限公司 Dong Guan Guo Ya Connectors co., l td.			
	APPROVAL	CHECK	DRAWN	DATE
	Yangzhengguo	Yangjinyi	Lvtiansheng	2016/08/26

PART NO.:				
A1508WVS-2*05-LPSW				
TITLE:				
1.50mm SMT 180° Packing				
UNIT	SCALE	SHEET	REV	NUMBER
mm	1:1	1/1	A0	A-000